



HC 275

**275tons capacity
Crawler Crane**

DATASHEET IMPERIAL

HC 275



WORKS FOR YOU.™

	Page:
Key	3
Highlights	3
Dimensions	4
Range Diagram 92HI Boom	6
Load Charts With 92HI Offset Tip Boom	7
Range Diagram #30 Jib	10
Load Charts With 92HI Offset Tip Boom, #30 Jib	11
Range Diagram 16HL Jib	17
Load Charts With 92HI Offset Tip Boom, 16HL Jib	18
Range Diagram 77H Taper Tip Luffing Jib	24
Load Charts With 92HI Luffing Tip Boom + 77H Taper Tip Luffing Jib	25
Range Diagram 77H Taper Tip Luffing Jib + 16HL Fixed Jib	28
Load Charts With 92HI Luffing Tip Boom + 77H Taper Tip Luffing Jib + 16HL Fixed Jib	29
Technical Description Hydraulic Crawler Crane	34
Transport Example for HC 275	35

HIGHLIGHTS

HC 275

- ▶ 275 tons maximum lift capacity
- ▶ Power up/down and freefall on main and auxiliary drums
- ▶ Quiet, comfortable operator's cab with excellent viewing range
- ▶ Shockless stop system gradually retards operating speed to reduce shocks when crane approaches lifting load or boom limits
- ▶ Two speed travel allows operator to select the best speed and power control for any condition
- ▶ Superior transportability:
 - 11 ft 6 in. width
 - 11 ft 3 in. height
- ▶ Hydraulic counterweight removal system simplifies installation and removal

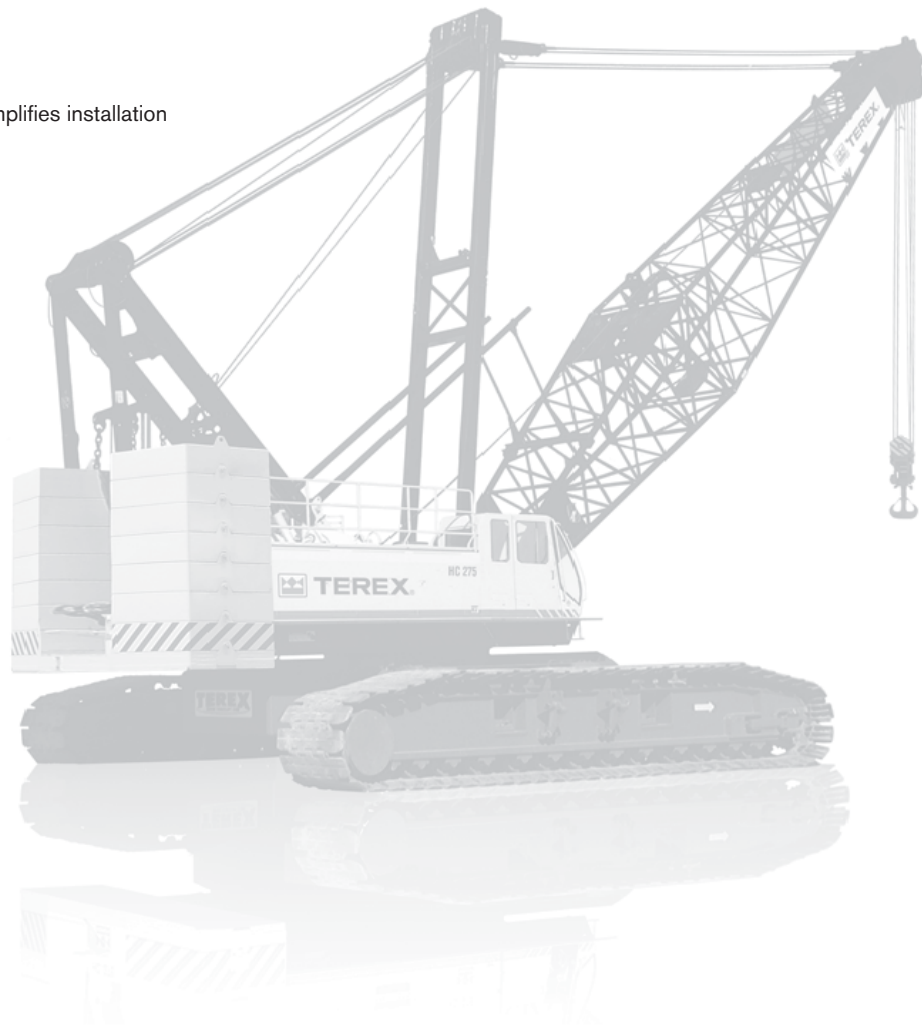

KEY



Counterweight

CB

Central ballast

DIMENSIONS

HC 275

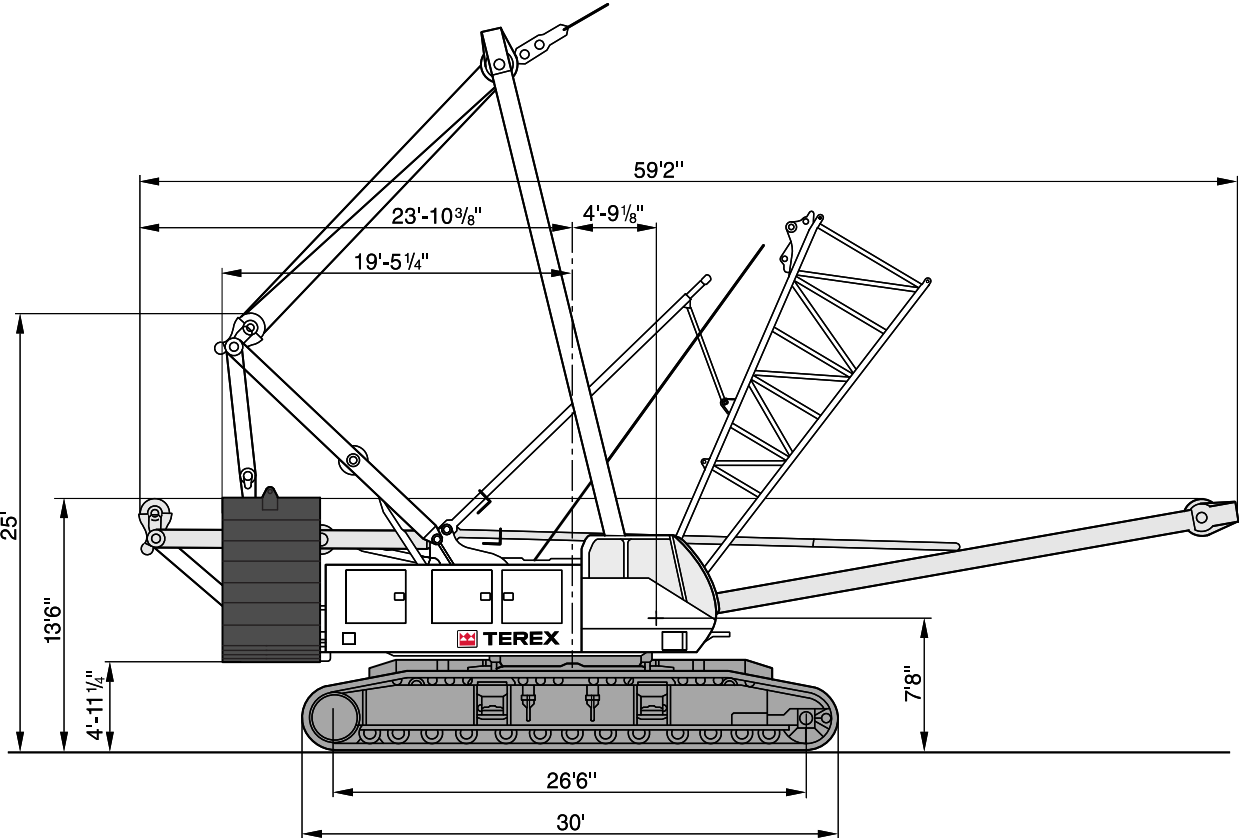

DIMENSIONS

HC 275

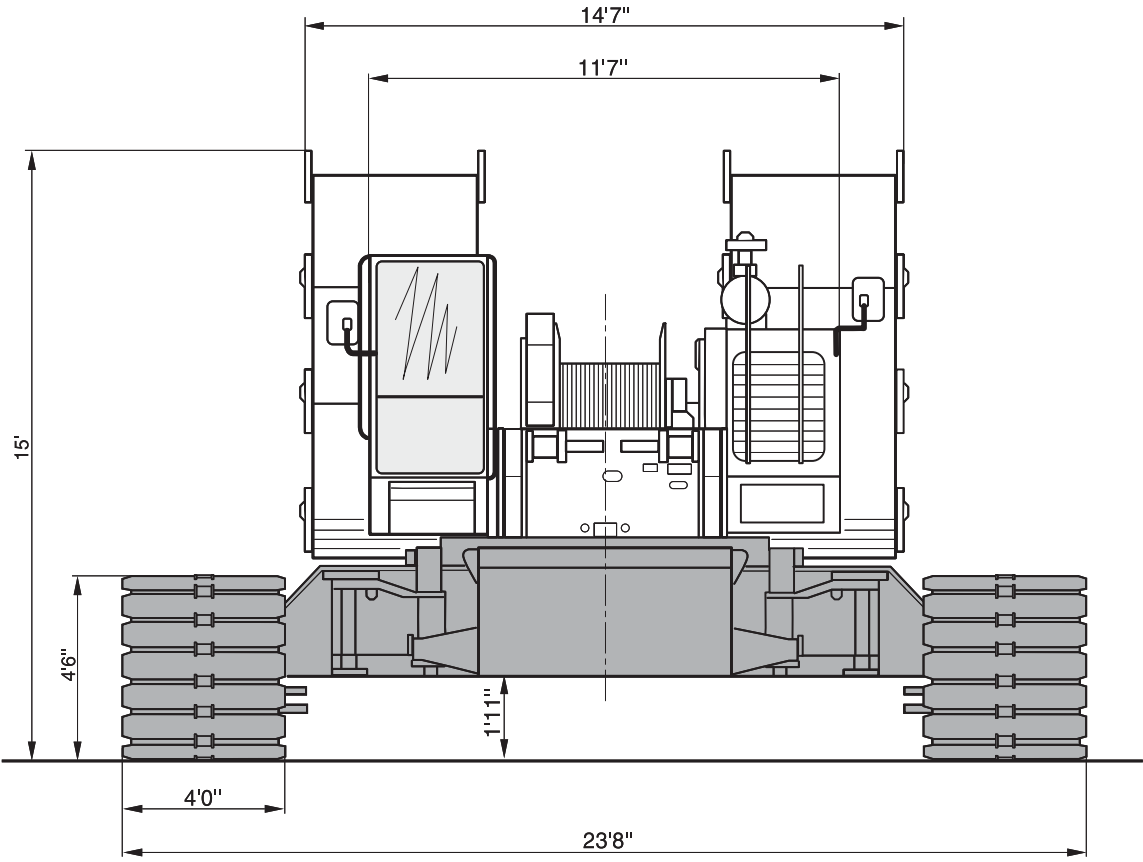

RANGE DIAGRAM

HC 275

92HI Boom

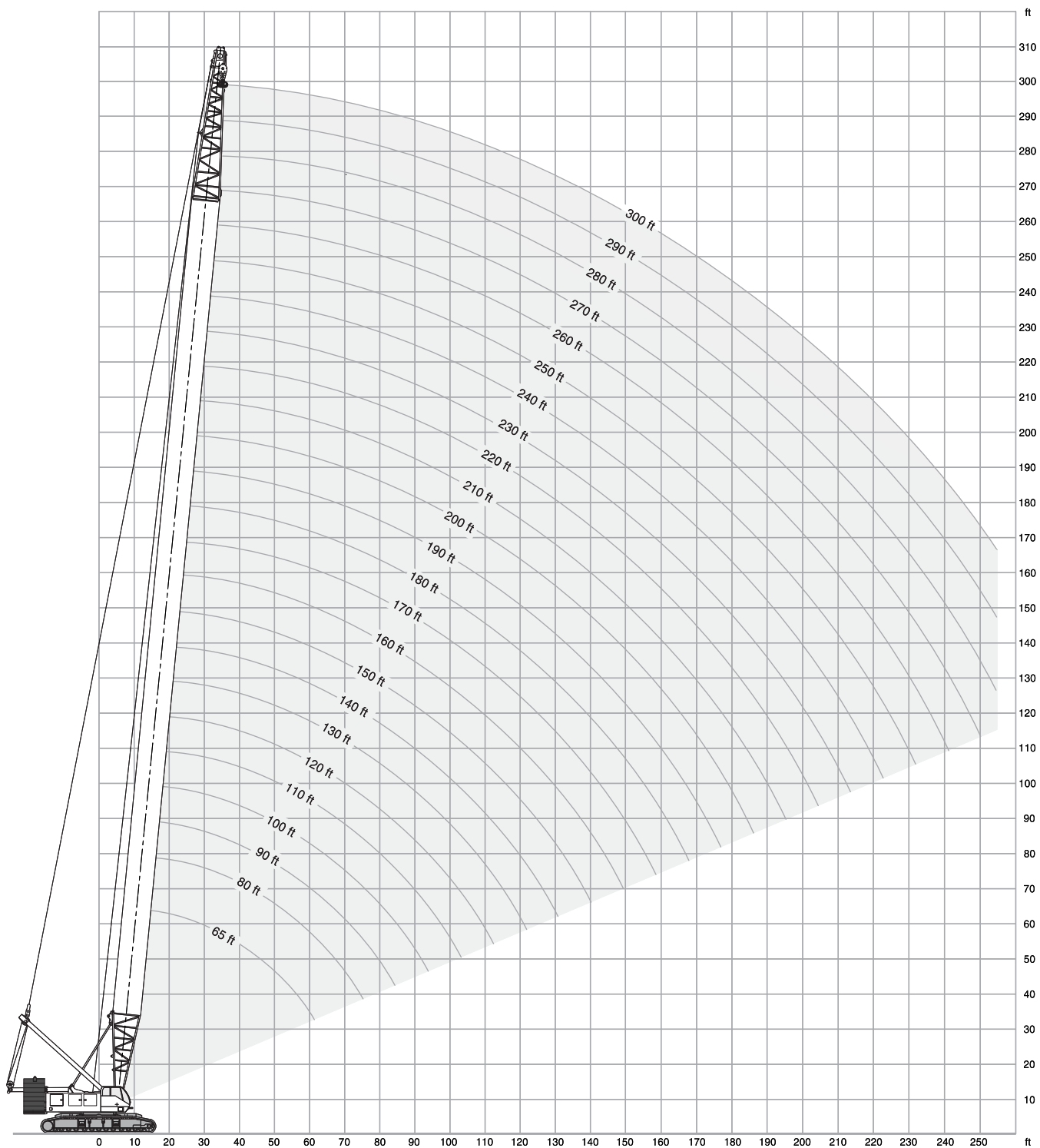

LOAD CHART

HC 275

With 92HI Offset Tip Boom

195,000 lb + 64,000 lb CB		360°											ANSI B 30.5
Radius (feet)	Boom length (feet)												
	65	80	100	120	140	160	180	200	220	240	260	280	300
16	550.000	-	-	-	-	-	-	-	-	-	-	-	-
20	438.430	438.040	-	-	-	-	-	-	-	-	-	-	-
25	350.740	350.420	349.990	349.560	-	-	-	-	-	-	-	-	-
30	292.250	291.950	291.560	291.180	281.420	268.190	-	-	-	-	-	-	-
35	232.570	232.830	232.180	231.450	231.040	227.390	212.500	193.970	-	-	-	-	-
40	191.980	292.200	191.530	190.780	190.370	189.490	188.840	183.030	156.330	119.340	-	-	-
50	141.340	141.520	140.800	140.010	139.590	138.670	138.010	137.100	136.180	119.340	107.130	84.270	74.730
60	111.040	111.220	110.500	109.710	109.320	108.380	107.760	106.830	105.890	105.180	104.250	83.540	73.910
70	-	90.940	90.190	89.380	88.970	88.000	87.350	86.380	85.410	84.680	83.700	82.110	72.390
80	-	76.540	75.850	75.080	74.720	73.780	73.170	72.230	71.290	70.590	69.630	68.850	67.920
90	-	-	64.980	64.200	63.820	62.870	62.250	61.290	60.330	59.620	58.640	57.860	56.900
100	-	-	56.510	55.730	55.360	54.390	53.770	52.790	51.820	51.100	50.110	49.310	48.330
120	-	-	-	43.430	43.600	42.070	41.440	40.440	39.890	39.210	38.240	37.490	36.540
140	-	-	-	-	34.660	33.760	33.200	32.850	31.310	30.620	29.650	28.900	27.920
160	-	-	-	-	-	27.470	26.910	25.960	25.010	24.340	23.350	22.580	21.610
180	-	-	-	-	-	-	21.830	21.160	20.210	19.520	18.530	17.770	16.780
200	-	-	-	-	-	-	-	16.120	16.420	15.730	14.740	13.970	12.980
220	-	-	-	-	-	-	-	-	11.230	12.680	11.670	10.900	9.900
240	-	-	-	-	-	-	-	-	-	7.380	-	-	-

150,400 lb + 0 lb CB		360°										ANSI B 30.5
Radius (feet)	Boom length (feet)											
	90	100	120	140	160	180	200	220	240	260	280	
20	412.410	-	-	-	-	-	-	-	-	-	-	-
25	305.620	305.360	304.840	-	-	-	-	-	-	-	-	-
30	226.040	225.710	225.100	224.760	224.040	-	-	-	-	-	-	-
35	178.490	178.130	177.450	177.090	176.290	175.690	174.910	-	-	-	-	-
40	146.970	146.590	145.880	145.520	144.690	144.090	143.270	142.440	119.340	-	-	-
50	107.590	107.190	106.450	106.090	105.210	104.610	103.730	102.860	102.170	101.290	84.270	-
60	83.910	83.480	82.690	82.290	81.360	80.740	80.240	79.370	78.700	77.810	77.070	-
70	68.270	67.860	67.100	66.750	65.830	65.240	64.320	63.400	62.710	61.790	61.020	-
80	56.990	56.570	55.800	55.440	54.500	53.890	52.950	52.010	51.310	50.350	49.570	-
90	48.520	48.110	47.340	46.960	46.010	45.390	44.430	43.470	42.750	41.780	41.000	-
100	-	41.530	40.740	40.610	39.710	39.140	38.220	37.290	36.620	35.680	34.940	-
120	-	-	31.260	30.980	20.070	29.500	28.570	27.630	26.960	25.990	25.240	-
140	-	-	-	24.290	23.400	22.830	21.880	20.940	20.260	19.280	18.530	-
160	-	-	-	-	18.490	17.930	16.980	16.030	15.350	14.360	13.600	-
180	-	-	-	-	-	14.190	13.240	12.290	11.600	10.610	9.840	-
200	-	-	-	-	-	-	10.290	9.330	8.640	7.650	6.880	-
220	-	-	-	-	-	-	-	6.950	6.260	5.260	4.480	-
240	-	-	-	-	-	-	-	-	4.320	-	-	-

All ratings in pounds

Indicates ratings that are limited by strength of material or factors other than stability (tipping)

LOAD CHART

HC 275

With 92HI Offset Tip Boom

61,200 lb + 0 lb CB		360°								ANSI B 30.5
Radius (feet)	Boom length (feet)									
	65	80	100	120	140	160	180	200	210	
16	428.980	-	-	-	-	-	-	-	-	
20	288.850	289.730	-	-	-	-	-	-	-	
25	188.230	188.840	188.580	188.210	-	-	-	-	-	
30	138.350	138.790	138.370	137.850	137.610	136.980	-	-	-	
35	108.600	108.990	108.490	107.900	107.630	106.930	106.420	105.730	-	
40	88.740	89.050	88.470	87.810	87.510	86.720	86.170	85.400	85.020	
50	64.070	64.340	63.730	63.030	62.720	61.900	61.340	60.510	60.100	
60	49.190	49.420	48.760	48.030	47.690	46.810	46.230	45.340	44.920	
70	-	39.580	38.970	38.270	37.970	37.110	36.560	35.690	35.260	
80	-	32.420	31.820	31.120	30.810	29.930	29.370	28.480	28.030	
90	-	-	26.450	25.750	25.440	24.540	23.980	23.070	22.620	
100	-	-	22.240	21.560	21.260	20.350	19.780	18.860	18.400	
120	-	-	-	15.430	15.150	14.240	13.670	12.740	12.280	
140	-	-	-	-	10.900	10.010	9.440	8.490	8.020	
160	-	-	-	-	-	6.890	6.330	5.380	4.910	
180	-	-	-	-	-	-	3.950	-	-	

150,400 lb + 64,000 lb CB		360°								ANSI B 30.5
Radius (feet)	Boom length (feet)									
	65	80	100	120	140	160	180	200	220	
16	432.650	-	-	-	-	-	-	-	-	
20	343.630	343.020	-	-	-	-	-	-	-	
25	272.420	271.960	270.260	268.560	-	-	-	-	-	
30	224.890	224.510	222.880	221.270	220.400	218.380	-	-	-	
35	190.950	190.640	189.100	187.540	186.740	184.980	173.430	155.800	-	
40	162.820	163.040	162.370	161.880	161.520	159.860	158.860	155.800	127.130	
50	119.620	119.830	119.170	118.430	118.070	117.180	116.590	115.710	114.840	
60	93.950	93.770	93.050	92.260	91.870	90.930	90.310	89.380	88.440	
70	-	76.510	75.840	75.080	74.720	73.800	73.210	72.290	71.370	
80	-	64.090	63.400	62.630	62.270	61.330	60.720	59.780	58.840	
90	-	-	54.090	53.310	52.930	51.980	51.360	50.400	49.440	
100	-	-	46.840	46.050	45.680	44.710	44.090	43.110	42.140	
120	-	-	-	35.600	35.320	34.410	33.840	32.910	31.970	
140	-	-	-	-	27.960	27.070	26.500	25.550	24.610	
160	-	-	-	-	-	21.670	21.110	20.160	19.210	
180	-	-	-	-	-	-	17.000	16.040	15.100	
200	-	-	-	-	-	-	-	12.810	11.840	
220	-	-	-	-	-	-	-	-	9.320	

All ratings in pounds

Indicates ratings that are limited by strength of material or factors other than stability (tipping)

NOTES TO LIFTING CAPACITY

HC 275

Main Boom Chart Information

92HI Offset Tip

Boom size	25' Inner	15' Center	10' Center	20' Center	50' Center	40' Outer
65	1	0	0	0	0	1
80	1	1	0	0	0	1
90	1	1	1	0	0	1
100	1	1	0	1	0	1
110	1	1	1	1	0	1
120	1	1	2	1	0	1
130	1	1	0	0	1	1
140	1	1	1	0	1	1
150	1	1	0	1	1	1
160	1	1	1	1	1	1
170	1	1	2	1	1	1
180	1	1	0	0	2	1
190	1	1	1	0	2	1
200	1	1	0	1	2	1
210	1	1	1	1	2	1
220	1	1	2	1	2	1
230	1	1	0	0	3	1
240	1	1	1	0	3	1
250	1	1	0	1	3	1
260	1	1	1	1	3	1
270	1	1	2	1	3	1
280	1	1	0	0	4	1
290	1	1	1	0	4	1
300	1	1	0	1	4	1

For Main Boom Use Only

Load Hoisting Information – 1 1/8 Inch Diameter EEIPS Wire Rope			
Maximum Lifting Capacity (lb)	Minimum Parts of Line	Maximum hoisting distance (feet)	
		Main hoist	Auxiliary hoist
550.000	14	90	90
490.280	12	105	105
449.420	11	110	110
408.570	10	130	130
367.710	9	145	145
326.850	8	160	160
286.000	7	185	185
245.140	6	215	215
204.280	5	260	260
163.420	4	325	325
122.570	3	435	435
81.710	2	655	655
40.850	1	1.310	1.310

RANGE DIAGRAM

HC 275

#30 Jib

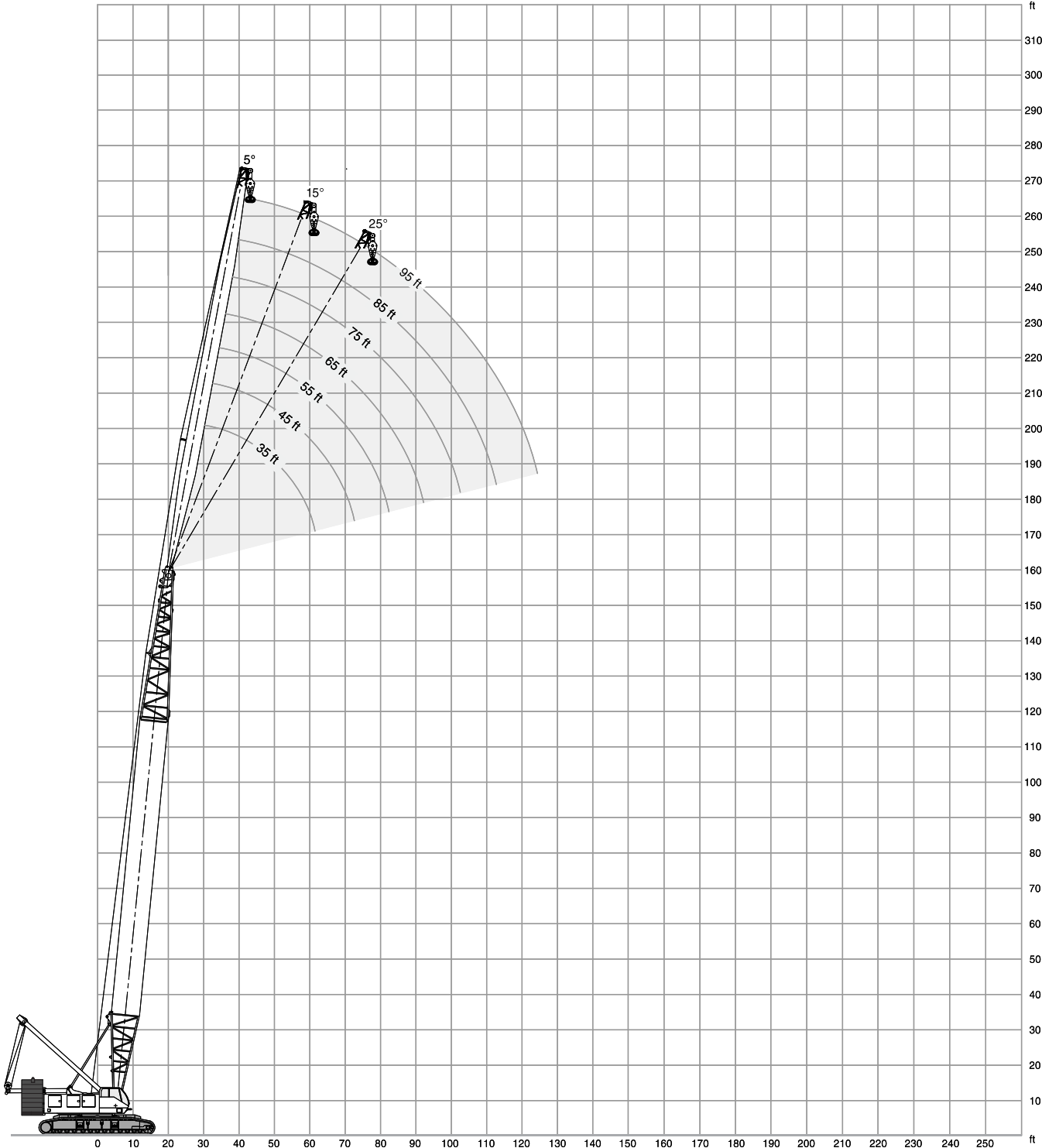

LOAD CHART

HC 275

With 92HI Offset Tip Boom, #30 Jib

195,000 lb + 64,000 lb CB				360°				ANSI B 30.5		
Jib length (feet)		35								
Boom length (feet)		90			110			130		
Radius (feet)	Offset (degrees)	5	15	25	5	15	25	5	15	25
30		60.000	-	-	60.000	-	-	-	-	-
35		60.000	60.000	-	60.000	60.000	-	60.000	-	-
40		60.000	60.000	60.000	60.000	60.000	-	60.000	60.000	-
50		60.000	60.000	54.780	60.000	60.000	59.740	60.000	60.000	59.930
60		60.000	60.000	48.790	60.000	60.000	53.610	60.000	60.000	57.570
70		60.000	57.480	44.090	60.000	60.000	48.670	60.000	60.000	52.530
80		60.000	51.220	40.500	60.000	57.340	44.800	60.000	60.000	48.500
90		54.310	46.420	40.500	60.000	52.700	41.640	60.000	56.870	45.100
100		-	-	-	55.730	48.500	40.580	56.170	52.750	42.420
120		-	-	-	-	-	-	43.920	43.920	40.510

Jib length (feet)		35								
Boom length (feet)		150			170			190		
Radius (feet)	Offset (degrees)	5	15	25	5	15	25	5	15	25
35		60.000	-	-	-	-	-	-	-	-
40		60.000	-	-	60.000	-	-	-	-	-
50		60.000	60.000	59.830	60.000	60.000	59.740	60.000	60.000	-
60		60.000	60.000	59.830	60.000	60.000	59.740	60.000	60.000	59.650
70		60.000	60.000	44.710	60.000	60.000	58.720	60.000	60.000	59.650
80		60.000	60.000	51.710	60.000	60.000	54.390	60.000	60.000	56.860
90		60.000	60.000	48.280	60.000	60.000	50.960	60.000	60.000	53.380
100		55.040	55.050	45.280	53.950	53.960	48.100	53.140	53.140	50.340
120		42.780	42.780	40.680	41.670	41.670	41.680	40.850	40.850	40.860
140		34.610	34.610	34.620	33.540	33.550	33.550	32.780	32.790	32.790
160		-	-	-	27.310	27.310	27.320	26.540	26.540	26.550
180		-	-	-	-	-	-	21.770	21.780	21.780

All ratings in pounds

Indicates ratings that are limited by strength of material or factors other than stability (tipping)

LOAD CHART

HC 275

With 92HI Offset Tip Boom, #30 Jib

195,000 lb + 64,000 lb CB				360°						ANSI B 30.5		
Jib length (feet)		35										
Boom length (feet)		210			230			250				
Radius (feet)	Offset (degrees)	5	15	25	5	15	25	5	15	25		
50		60.000	60.000	-	60.000	-	-	60.000	-	-		
60		60.000	60.000	59.560	60.000	60.000	59.460	60.000	60.000	59.370		
70		60.000	60.000	59.560	60.000	60.000	59.460	60.000	60.000	59.370		
80		60.000	60.000	59.040	60.000	60.000	59.460	60.000	60.000	59.370		
90		60.000	60.000	55.630	59.650	59.660	57.630	58.590	58.600	58.610		
100		52.040	52.040	52.050	51.170	51.170	51.180	50.110	50.110	50.120		
120		40.240	40.240	40.250	39.410	39.410	34.800	38.370	38.380	38.380		
140		31.710	21.710	31.710	30.870	30.870	30.880	29.830	29.830	29.830		
160		25.460	25.460	25.470	24.620	24.620	24.630	23.560	23.570	23.570		
180		20.680	20.690	20.690	19.850	19.850	19.860	18.780	18.780	18.790		
200		16.920	16.920	16.930	16.080	16.090	16.090	15.010	15.010	15.020		
220		-	-	-	13.040	13.040	13.050	11.970	11.970	11.980		
240		-	-	-	-	-	-	9.450	9.460	9.470		

Jib length (feet)		35		
Boom length (feet)		270		
Radius (feet)	Offset (degrees)	5	15	25
60		60.000	57.380	-
70		60.000	54.860	49.240
80		57.190	52.360	47.740
90		54.310	50.160	46.120
100		49.050	47.880	44.480
120		37.350	37.360	37.360
140		28.790	28.800	28.800
160		22.520	22.520	22.530
180		17.730	17.730	17.740
200		13.960	13.960	13.960
220		10.900	10.900	10.910
240		8.390	8.390	8.400
260		6.290	6.290	6.300

All ratings in pounds

Indicates ratings that are limited by strength of material or factors other than stability (tipping)

LOAD CHART

HC 275

With 92HI Offset Tip Boom, #30 Jib

195,000 lb + 64,000 lb CB 360° ANSI B 30.5

Jib length (feet)		55								
Boom length (feet)		140			160			180		
Radius (feet)	Offset (degrees)	5	15	25	5	15	25	5	15	25
40		60.000	-	-	-	-	-	-	-	-
50		60.000	60.000	-	60.000	60.000	-	60.000	-	-
60		60.000	56.160	38.790	60.000	59.090	38.740	60.000	60.000	-
70		60.000	49.980	38.790	60.000	53.090	38.740	60.000	55.610	38.700
80		59.210	44.930	37.500	60.000	47.970	38.740	60.000	50.740	38.700
90		53.090	40.920	34.640	57.470	43.790	36.670	60.000	46.410	38.360
100		47.920	40.110	32.290	52.160	40.280	34.240	54.140	42.710	35.900
120		40.250	35.040	28.400	42.730	37.160	30.250	41.860	39.200	31.870
140		35.020	31.220	25.650	34.640	33.250	27.310	33.820	22.720	28.900
160		-	-	-	28.410	28.420	25.120	27.580	27.580	26.540
180		-	-	-	-	-	-	22.830	22.830	22.840

Jib length (feet)		55								
Boom length (feet)		200			220			240		
Radius (feet)	Offset (degrees)	5	15	25	5	15	25	5	15	25
50		60.000	-	-	60.000	-	-	-	-	-
60		60.000	60.000	-	60.000	60.000	-	60.000	-	-
70		60.000	57.610	38.650	60.000	59.320	38.600	60.000	60.000	38.550
80		60.000	53.150	38.650	60.000	54.890	38.600	60.000	56.670	38.550
90		60.000	48.800	38.650	60.000	51.040	38.600	59.580	52.800	38.550
100		53.050	45.100	37.380	51.970	47.230	38.600	51.090	49.270	38.550
120		40.740	40.210	33.390	40.230	40.230	34.780	39.400	39.400	36.000
140		32.750	32.750	30.270	31.690	31.700	31.660	30.850	30.850	30.860
160		26.500	26.500	26.510	25.440	25.450	25.450	24.600	24.600	24.610
180		21.730	21.730	21.740	20.660	20.660	20.670	19.820	19.820	19.830
200		17.980	17.980	17.990	16.900	16.900	16.910	16.050	16.050	16.060
220		-	-	-	13.860	13.870	13.880	13.010	13.020	13.020
240		-	-	-	-	-	-	10.510	10.510	10.520

Jib length (feet)		55								
Boom length (feet)		260			280					
Radius (feet)	Offset (degrees)	5	15	25	5	15	25			
60		60.000	-	-	48.350	-	-			
70		60.000	53.180	-	45.380	37.580	-			
80		58.460	51.530	38.510	42.620	36.270	31.890			
90		55.580	49.570	38.510	40.170	34.690	31.030			
100		50.010	47.680	38.510	36.650	32.260	30.030			
120		38.350	38.350	37.180	32.910	30.440	27.960			
140		29.800	29.800	29.810	28.920	27.860	25.920			
160		23.530	23.540	23.540	22.650	22.650	22.660			
180		18.740	18.750	18.750	17.860	17.860	17.870			
200		14.970	14.970	14.980	14.090	14.090	14.100			
220		11.930	11.930	11.940	11.030	11.040	11.050			
240		9.410	9.420	9.430	8.520	8.520	8.530			
260		7.320	7.330	7.340	6.410	6.420	6.430			
280		-	-	-	4.480	4.640	4.650			

All ratings in pounds

 Indicates ratings that are limited by strength of material or factors other than stability (tipping)

LOAD CHART

HC 275

With 92HI Offset Tip Boom, #30 Jib

195,000 lb + 64,000 lb CB				360°			ANSI B 30.5			
Jib length (feet)		75								
Boom length (feet)		190			210			230		
Radius (feet)	Offset (degrees)	5	15	25	5	15	25	5	15	25
50		42.120	-	-	-	-	-	-	-	-
60		36.150	-	-	36.440	-	-	36.350	-	-
70		35.050	31.710	-	35.310	31.800	-	36.350	31.700	-
80		33.980	30.930	28.010	34.380	31.060	28.240	34.540	31.100	28.290
90		32.970	30.010	27.230	33.470	30.480	27.550	33.730	30.480	27.710
100		32.130	29.180	26.310	32.540	29.540	26.900	32.830	29.860	27.090
120		30.210	27.480	23.350	30.940	27.960	24.230	31.290	28.440	25.120
140		28.390	26.200	21.120	29.160	26.690	21.940	29.880	27.060	22.750
160		26.880	24.330	19.250	26.320	25.520	20.150	25.440	25.440	20.870
180		22.630	21.970	17.780	21.540	21.540	18.580	20.660	20.670	19.330
200		-	-	-	17.780	17.780	17.380	16.910	16.910	16.920
220		-	-	-	-	-	-	13.860	13.860	13.870

Jib length (feet)		75								
Boom length (feet)		250			270					
Radius (feet)	Offset (degrees)	5	15	25	5	15	25			
60		36.570	-	-	-	-	-			
70		35.660	31.770	-	35.600	-	-			
80		34.770	31.240	-	34.750	31.080	-			
90		33.950	30.660	27.910	34.000	30.600	27.750			
100		33.180	30.030	27.220	33.230	30.120	27.390			
120		31.760	28.750	25.820	31.970	29.110	26.410			
140		30.350	27.460	23.510	29.600	27.830	24.200			
160		24.390	24.390	21.590	23.330	23.340	22.330			
180		19.590	19.600	19.610	18.550	18.550	18.560			
200		15.830	15.830	15.840	14.770	14.770	14.780			
220		12.780	12.790	12.800	11.720	11.730	11.740			
240		10.280	10.280	10.300	9.200	9.210	9.220			
260		-	-	-	7.100	7.110	7.120			

All ratings in pounds

Indicates ratings that are limited by strength of material or factors other than stability (tipping)

LOAD CHART

HC 275

With 92HI Offset Tip Boom, #30 Jib

195,000 lb + 64,000 lb CB				360°			ANSI B 30.5			
Jib length (feet)		95								
Boom length (feet)		240			250			260		
Radius (feet)	Offset (degrees)	5	15	25	5	15	25	5	15	25
70		23.920	-	-	24.100	-	-	24.100	-	-
80		23.200	19.790	-	23.360	19.870	-	23.430	19.960	-
90		22.440	19.150	-	22.650	19.230	-	22.670	19.300	-
100		21.540	18.480	16.260	21.740	18.630	16.290	21.960	18.680	16.360
120		19.960	17.330	15.450	20.190	17.480	15.480	20.340	17.600	15.590
140		18.600	16.360	14.690	18.810	16.540	14.790	18.970	16.620	14.830
160		17.370	15.540	14.120	17.590	15.650	14.160	17.800	15.750	14.250
180		16.400	14.790	13.540	16.580	14.890	13.620	16.810	15.050	13.710
200		15.460	14.110	13.120	15.690	14.260	13.200	15.600	14.380	13.230
220		13.630	13.540	12.710	13.080	13.090	12.790	12.550	12.560	12.570
240		11.130	11.130	11.150	10.570	10.580	10.590	10.040	10.050	10.060
260		-	-	-	-	-	-	7.950	7.950	7.970

Jib length (feet)		95		
Boom length (feet)		270		
Radius (feet)	Offset (degrees)	5	15	25
70		24.190	-	-
80		23.490	-	-
90		22.780	19.370	-
100		22.120	18.820	16.400
120		20.570	17.730	15.630
140		19.190	16.740	14.930
160		18.000	15.910	14.310
180		16.990	15.160	13.800
200		15.070	14.540	13.320
220		12.020	12.030	12.040
240		9.510	9.520	9.530
260		7.400	7.410	7.420

All ratings in pounds

Indicates ratings that are limited by strength of material or factors other than stability (tipping)

NOTES TO LIFTING CAPACITY

HC 275

Jib Chart Information, #30 Jib

#30 Jib Composition Chart

Jib length (feet)	12.5' Inner	10' Center	30' Center	12.5' Outer	Eff. jib weight (pounds)
35	1	1	0	1	5.430
45	1	2	0	1	6.020
55	1	0	1	1	6.350
65	1	1	1	1	5.900
75	1	2	1	1	7.460
85	1	0	2	1	7.750
95	1	1	2	1	8.440

#30 Jib Information

92 HI Offset Tip Boom Maximum Boom & Jib Self-Erection Data		
	Boom length (feet)	Jib length #30 Jib (feet)
Blocked over the end	300	0
	290	0
	280	65
	270	95
Over the side	280	0
	270	0
	260	35
	250	65
	240	95

Load Hoisting Information – 1 1/8 Inch Diameter EEIPS Wire Rope			
Maximum Lifting Capacity (lb)	Minimum Parts of line	Maximum hoisting distance (feet)	
		Main hoist	Auxiliary hoist
60.000	2	655	655
40.850	1	1.310	1.310

RANGE DIAGRAM

HC 275

16HL Jib

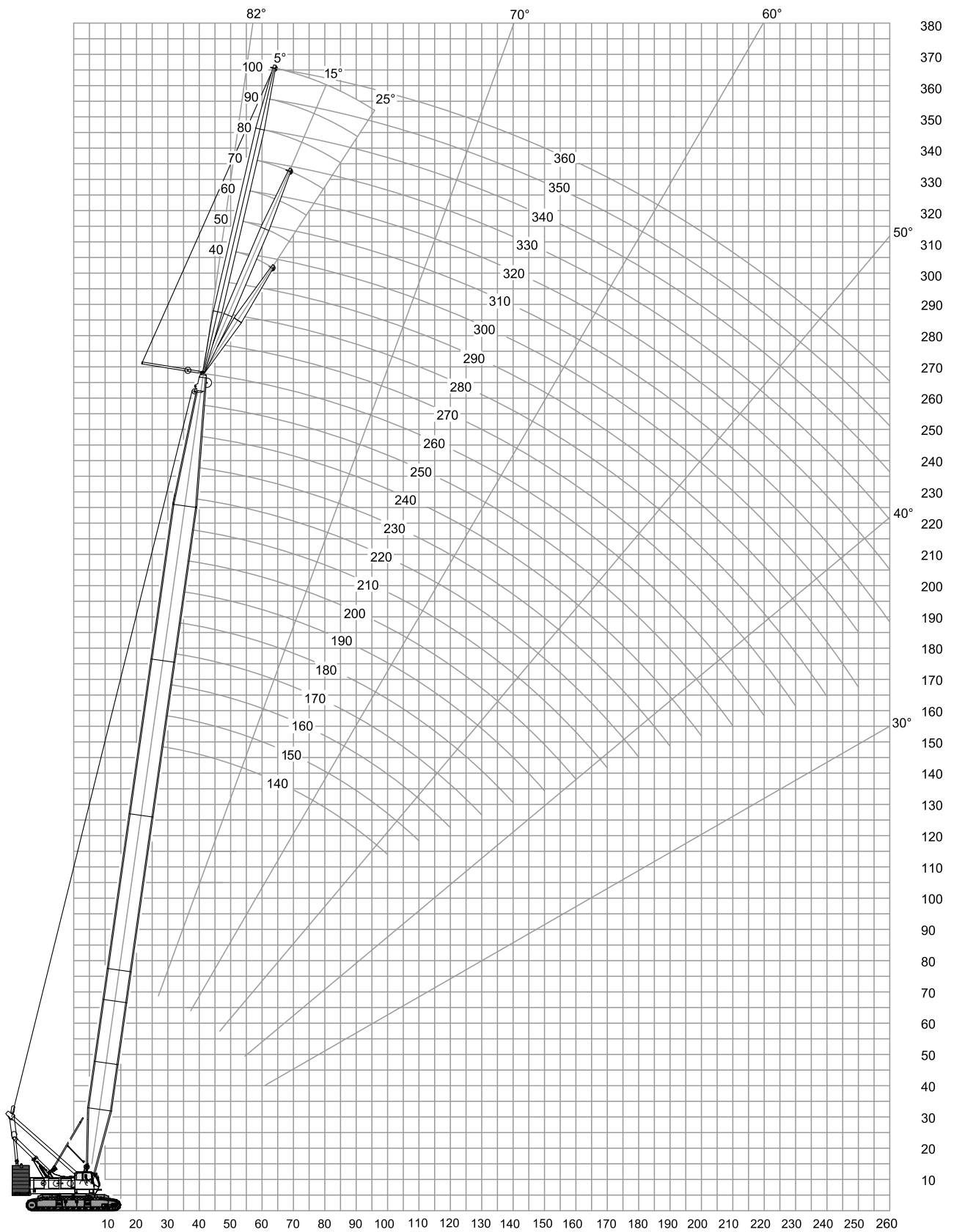

LOAD CHART

HC 275

With 92HI Offset Tip Boom, 16HL Jib

195,000 lb + 64,000 lb CB				360°			ANSI B 30.5			
Jib length (feet)		40								
Boom length (feet)		100			120			140		
Radius (feet)	Offset (degrees)	5	15	25	5	15	25	5	15	25
30		32.000	-	-	-	-	-	-	-	-
35		32.000	32.000	-	32.000	-	-	32.000	-	-
40		32.000	32.000	-	32.000	32.000	-	32.000	-	-
50		32.000	32.000	30.670	32.000	32.000	31.870	32.000	32.000	23.000
60		32.000	32.000	27.430	32.000	32.000	28.830	32.000	32.000	29.930
70		32.000	32.000	24.910	32.000	32.000	26.330	32.000	32.000	27.510
80		32.000	29.470	22.820	32.000	32.000	24.280	32.000	32.000	25.480
90		31.700	26.670	21.190	32.000	29.170	22.510	32.000	31.530	23.770
100		28.690	24.440	19.820	32.000	26.840	21.180	32.000	28.920	22.360
120		-	-	-	27.090	23.210	18.970	29.900	25.050	20.060
140		-	-	-	-	-	-	25.860	22.270	18.380

Jib length (feet)		40								
Boom length (feet)		160			180			200		
Radius (feet)	Offset (degrees)	5	15	25	5	15	25	5	15	25
40		32.000	-	-	32.000	-	-	-	-	-
50		32.000	32.000	32.000	32.000	32.000	-	32.000	32.000	-
60		32.000	32.000	31.030	32.000	32.000	32.000	32.000	32.000	32.000
70		32.000	32.000	28.620	32.000	32.000	29.920	32.000	32.000	30.350
80		32.000	32.000	26.540	32.000	32.000	27.900	32.000	32.000	28.360
90		32.000	32.000	24.790	32.000	32.000	26.270	32.000	32.000	26.650
100		32.000	31.040	23.340	32.000	32.000	24.770	32.000	32.000	25.160
120		32.000	26.860	21.030	32.000	29.410	22.360	32.000	30.230	22.730
140		28.300	23.910	19.270	30.580	26.220	20.480	32.000	26.890	20.910
160		25.050	21.660	18.040	27.160	23.620	19.050	26.690	24.300	19.380
180		-	-	-	23.120	21.730	18.020	21.980	21.980	18.260
200		-	-	-	-	-	-	18.290	18.300	17.450

All ratings in pounds

Indicates ratings that are limited by strength of material or factors other than stability (tipping)

LOAD CHART

HC 275

With 92HI Offset Tip Boom, 16HL Jib

195,000 lb + 64,000 lb CB				360°			ANSI B 30.5			
Jib length (feet)		40								
Boom length (feet)		220			240			260		
Radius (feet)	Offset (degrees)	5	15	25	5	15	25	5	15	25
50		32.000	-	-	32.000	-	-	-	-	-
60		32.000	32.000	32.000	32.000	32.000	-	32.000	32.000	-
70		32.000	32.000	31.000	32.000	32.000	31.640	32.000	32.000	32.000
80		32.000	32.000	29.160	32.000	32.000	29.840	32.000	32.000	30.420
90		32.000	32.000	27.440	32.000	32.000	28.170	32.000	32.000	27.420
100		32.000	32.000	26.050	32.000	32.000	26.690	32.000	32.000	26.050
120		32.000	31.910	23.520	32.000	32.000	24.250	32.000	32.000	23.860
140		31.800	28.360	21.630	30.950	29.770	22.320	29.850	29.860	22.930
160		25.600	25.600	20.070	24.730	24.740	20.770	23.630	23.640	21.370
180		20.860	20.870	18.910	20.000	20.010	19.440	18.890	18.890	18.900
200		17.170	17.180	17.190	16.280	16.290	16.300	15.170	15.170	15.190
220		14.200	14.210	14.220	13.300	13.310	13.330	12.170	12.180	12.200
240		-	-	-	10.880	10.890	10.910	9.730	9.740	9.750
260		-	-	-	-	-	-	7.710	7.720	7.740

Jib length (feet)		40								
Boom length (feet)		280			300					
Radius (feet)	Offset (degrees)	5	15	25	5	15	25			
60		32.000	32.000	-	32.000	-	-			
70		32.000	32.000	32.000	32.000	32.000	32.000			
80		32.000	32.000	30.960	32.000	32.000	31.530			
90		32.000	32.000	29.370	32.000	32.000	29.940			
100		32.000	32.000	27.940	32.000	32.000	28.470			
120		32.000	32.000	25.520	32.000	32.000	26.170			
140		28.950	28.950	23.600	27.890	27.890	24.090			
160		22.730	22.730	21.970	21.650	21.660	21.670			
180		17.980	17.990	18.000	16.890	16.900	16.910			
200		14.250	14.250	14.270	13.150	13.160	13.170			
220		11.260	11.260	11.280	10.150	10.160	10.170			
240		8.800	8.800	8.820	7.680	7.690	7.710			
260		6.760	6.770	6.780	5.560	5.640	5.650			
280		4.680	4.940	5.090	3.210	3.480	3.670			

All ratings in pounds

Indicates ratings that are limited by strength of material or factors other than stability (tipping)

LOAD CHART

HC 275

With 92HI Offset Tip Boom, 16HL Jib

195,000 lb + 64,000 lb CB				360°			ANSI B 30.5			
Jib length (feet)		60								
Boom length (feet)		160			180			200		
Radius (feet)	Offset (degrees)	5	15	25	5	15	25	5	15	25
50		29.040	-	-	29.210	-	-	29.340	-	-
60		27.960	25.480	22.840	28.160	25.490	-	28.400	25.630	-
70		27.100	24.710	21.050	27.270	24.890	21.580	27.580	24.990	22.020
80		26.150	24.050	19.550	26.450	24.310	20.130	26.870	24.380	20.570
90		25.410	23.490	18.280	25.720	23.710	18.800	26.060	23.190	19.270
100		24.630	22.760	17.160	25.010	23.190	17.680	25.380	23.380	18.220
120		23.340	19.690	15.350	23.770	20.760	15.880	24.210	21.740	16.370
140		21.100	17.420	13.930	22.710	18.420	14.480	23.100	19.340	14.970
160		18.600	15.670	12.920	19.970	16.550	13.380	21.440	17.430	13.840
180		-	-	-	17.910	15.150	12.530	19.140	15.940	12.950
200		-	-	-	-	-	-	17.400	14.720	12.300

Jib length (feet)		60								
Boom length (feet)		220			240					
Radius (feet)	Offset (degrees)	5	15	25	5	15	25			
50		29.370	-	-	-	-	-			
60		28.600	25.610	-	28.510	-	-			
70		27.760	25.090	22.330	27.780	24.980	-			
80		27.080	24.560	20.940	27.120	24.490	21.330			
90		26.330	24.050	19.750	26.490	24.010	20.080			
100		25.710	23.500	18.630	25.920	23.580	19.070			
120		24.550	22.630	16.870	24.700	22.730	17.290			
140		23.420	20.220	15.410	23.730	21.070	15.860			
160		22.580	18.280	14.260	22.860	19.040	14.670			
180		20.380	16.690	13.350	20.610	17.380	13.710			
200		17.780	15.410	12.600	16.890	16.050	12.920			
220		14.800	14.400	12.040	13.910	13.910	12.350			
240		-	-	-	11.460	11.470	11.490			

Jib length (feet)		60								
Boom length (feet)		260			280					
Radius (feet)	Offset (degrees)	5	15	25	5	15	25			
60		28.640	-	-	28.480	-	-			
70		27.940	24.990	-	27.810	24.900	-			
80		27.360	24.570	21.650	27.320	24.450	21.920			
90		26.720	24.080	20.430	26.690	24.100	20.750			
100		26.060	23.730	19.470	26.070	23.630	19.770			
120		24.980	22.880	17.630	25.090	22.930	17.980			
140		24.000	21.850	16.260	24.140	22.190	16.560			
160		23.090	19.810	15.040	23.280	20.490	15.370			
180		19.500	18.100	14.070	18.580	18.590	14.430			
200		15.770	15.780	13.260	14.840	14.850	13.610			
220		12.780	12.790	12.600	11.840	11.850	11.870			
240		10.320	10.330	10.350	9.370	9.380	9.400			
260		8.290	8.300	8.320	7.330	7.340	7.360			
280		-	-	-	5.620	5.630	5.650			

All ratings in pounds

Indicates ratings that are limited by strength of material or factors other than stability (tipping)



LOAD CHART

HC 275

With 92HI Offset Tip Boom, 16HL Jib

195,000 lb + 64,000 lb CB				360°						ANSI B 30.5		
Jib length (feet)				80								
Boom length (feet)				200			220			240		
Radius (feet)	Offset (degrees)	5	15	25	5	15	25	5	15	25		
60		16.660	-	-	16.820	-	-	16.860	-	-		
70		16.040	14.050	-	16.150	14.090	-	16.220	14.060	-		
80		15.460	13.640	11.980	15.610	13.650	12.000	15.680	13.690	-		
90		14.890	13.120	11.590	15.030	13.250	11.630	15.150	13.300	11.670		
100		14.350	12.670	11.260	14.570	12.770	11.310	14.700	12.900	11.350		
120		13.370	11.790	10.640	13.630	11.940	10.730	13.800	12.130	10.780		
140		12.410	11.110	10.150	12.720	11.260	10.220	13.010	11.420	10.300		
160		11.560	10.520	9.760	11.880	10.680	9.850	12.170	10.860	9.880		
180		10.880	10.050	9.470	11.170	10.240	9.550	11.440	10.340	9.580		
200		10.370	9.720	9.230	10.610	9.830	9.310	10.870	9.950	9.320		
220		-	-	-	10.140	9.550	8.990	10.340	9.660	3.150		
240		-	-	-	-	-	-	9.970	9.420	8.780		

Jib length (feet)				80					
Boom length (feet)				260			280		
Radius (feet)	Offset (degrees)	5	15	25	5	15	25		
60		16.900	-	-	-	-	-		
70		16.300	-	-	16.320	-	-		
80		15.810	13.680	-	15.810	13.660	-		
90		15.330	13.350	11.660	15.400	13.320	11.650		
100		14.850	13.000	11.340	14.910	13.060	11.350		
120		13.990	12.210	10.810	14.110	12.320	10.850		
140		13.220	11.540	10.360	13.370	11.680	10.360		
160		12.420	10.990	9.950	12.640	11.090	10.010		
180		11.710	10.510	9.610	11.930	10.590	9.680		
200		11.110	10.060	9.380	11.330	10.180	9.420		
220		10.580	9.720	9.190	10.790	9.830	9.200		
240		10.160	6.470	8.940	9.870	9.540	9.020		
260		8.770	8.780	8.620	7.820	7.830	7.850		
280		-	-	-	6.100	6.110	6.140		

All ratings in pounds

Indicates ratings that are limited by strength of material or factors other than stability (tipping)

LOAD CHART

HC 275

With 92HI Offset Tip Boom, 16HL Jib

195,000 lb + 64,000 lb CB				360°			ANSI B 30.5			
Jib length (feet)		100								
Boom length (feet)		250			270			290		
Radius (feet)	Offset (degrees)	5	15	25	5	15	25	5	15	25
70		9.810	-	-	9.890	-	-	9.970	-	-
80		9.270	7.330	-	9.360	-	-	9.450	-	-
90		8.730	6.990	-	8.850	7.040	-	8.970	7.010	-
100		9.290	6.710	5.600	8.390	6.710	5.750	8.510	6.750	5.520
120		7.500	6.160	5.240	7.630	6.210	5.210	7.720	6.230	5.180
140		6.820	5.720	4.920	6.940	5.760	4.910	7.050	5.790	4.880
160		6.290	5.350	4.660	6.380	5.380	4.640	6.530	5.400	4.620
180		5.820	5.020	4.460	5.920	5.050	4.440	6.020	5.080	4.430
200		5.430	4.770	4.280	5.540	4.800	4.270	5.630	4.830	4.250
220		5.100	4.540	4.150	5.180	4.580	4.120	5.290	4.580	4.100
240		4.830	4.380	4.070	4.920	4.400	4.030	4.990	4.400	3.980
260		-	-	-	4.700	4.250	3.970	4.760	4.260	3.920
280		-	-	-	-	-	-	4.570	4.140	3.870

All ratings in pounds

Indicates ratings that are limited by strength of material or factors other than stability (tipping)

NOTES TO LIFTING CAPACITY

HC 275

Jib Chart Information, 16HL Jib

16HL Jib Composition Chart

Jib length (feet)	20' Inner	10' Center	20' Center	20' Outer	Eff. jib weight (pounds)
40	1	0	0	1	1.500
50	1	1	0	1	2.050
60	1	0	1	1	2.600
70	1	1	1	1	3.150
90	1	0	2	1	3.700
90	1	1	2	1	4.350
100	1	0	3	1	4.950

16HL Jib Information

92 HI Offset Tip Boom Maximum Boom & Jib Self-Erection Data		
	Boom length (feet)	Jib length 16HL Jib (feet)
Blocked over the end	300	50
	290	100
Over the side	280	0
	270	70
	260	100

Load Hoisting Information – 1 1/8 Inch Diameter EEIPS Wire Rope			
Maximum Lifting Capacity (lb)	Minimum Parts of line	Maximum hoisting distance (feet)	
		Main hoist	Auxiliary hoist
32.000	1	1.310	1.310

RANGE DIAGRAM

HC 275

77H Taper Tip Luffing Jib

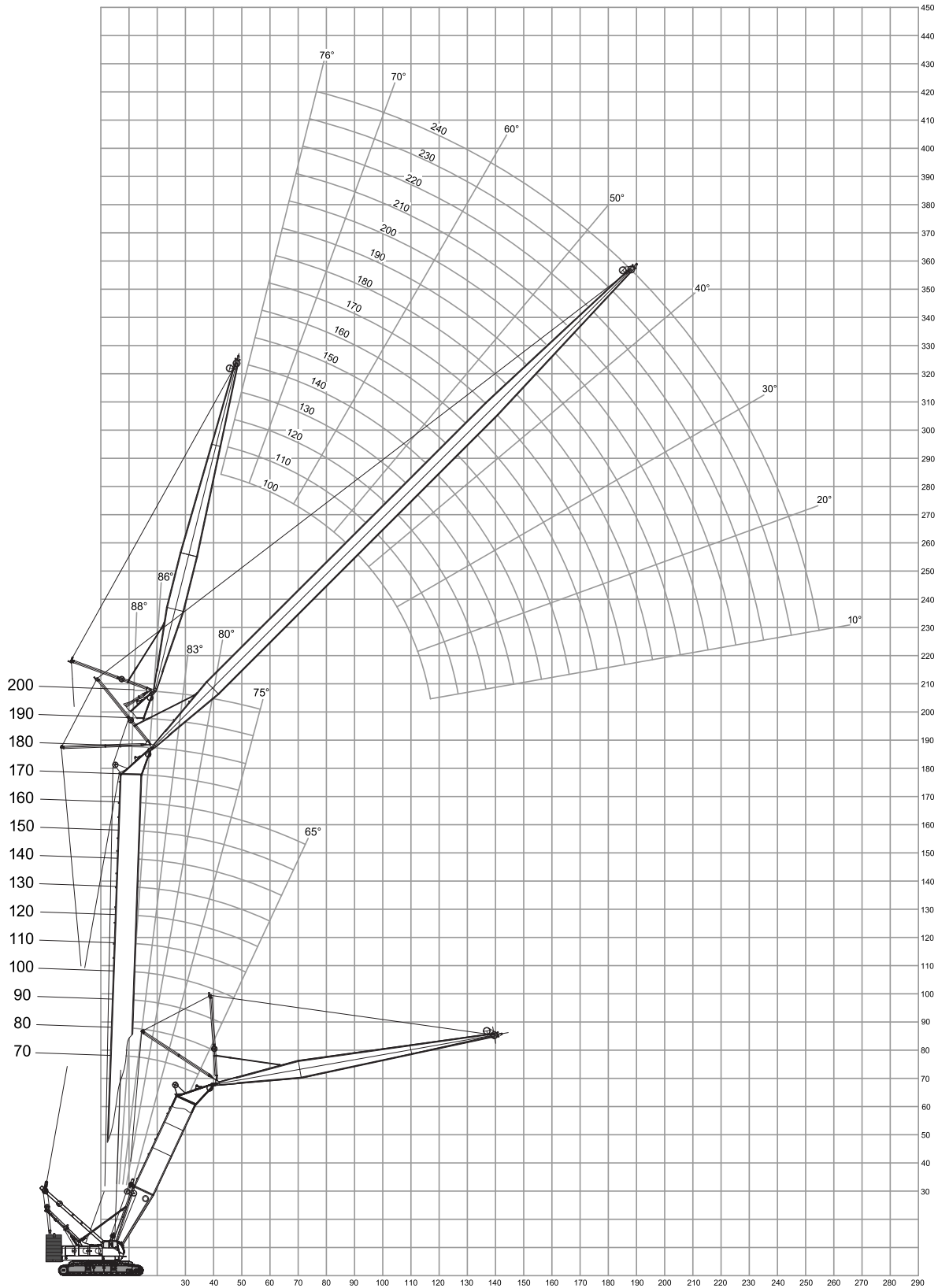

LOAD CHART

HC 275

With 92HI Luffing Tip Boom + 77H Taper Tip Luffing Jib

195,000 lb + 64,000 lb CB

360°

ANSI B 30.5

Boom Angle = 88 degrees

Boom length (feet)		70						
Radius (feet)	Luffer length (feet)							
	100	120	140	160	180	200	220	240
39	160.000	-	-	-	-	-	-	-
40	151.920	-	-	-	-	-	-	-
50	114.890	113.880	105.920	-	-	-	-	-
60	91.720	90.930	88.910	84.750	80.270	-	-	-
70	76.550	76.340	75.910	75.040	71.680	64.710	55.660	-
80	64.730	64.850	64.440	63.860	63.010	60.010	51.620	44.580
90	55.500	55.990	55.790	55.390	54.570	53.810	48.060	41.420
100	47.850	48.930	48.920	48.690	48.030	47.340	44.930	39.500
120	-	38.670	39.690	39.990	39.920	39.360	39.450	35.960
140	-	-	31.520	32.350	32.510	32.410	32.220	31.840
160	-	-	-	26.240	26.850	26.980	26.780	26.590
180	-	-	-	-	22.040	22.570	22.570	22.400
200	-	-	-	-	-	18.670	19.020	18.980
220	-	-	-	-	-	-	15.550	15.840
240	-	-	-	-	-	-	-	11.670

Boom length (feet)		90						
Radius (feet)	Luffer length (feet)							
	100	120	140	160	180	200	220	240
40	132.950	-	-	-	-	-	-	-
50	116.700	106.380	96.350	-	-	-	-	-
60	99.760	92.720	85.460	80.330	73.900	-	-	-
70	84.940	80.420	76.720	71.850	66.950	61.880	55.750	-
80	73.070	70.490	67.450	63.970	60.190	56.440	51.780	44.700
90	62.910	61.250	59.260	56.870	54.100	51.140	48.060	41.530
100	54.780	53.500	52.200	50.590	48.600	46.370	43.990	40.120
120	-	41.870	41.090	40.350	39.770	39.660	39.830	36.060
140	-	-	34.160	33.900	33.730	33.470	33.040	31.710
160	-	-	-	28.210	27.970	27.860	27.640	27.380
180	-	-	-	-	23.840	23.600	23.440	23.270
200	-	-	-	-	-	20.510	20.250	20.120
220	-	-	-	-	-	-	16.960	17.110
240	-	-	-	-	-	-	-	12.700

All ratings in pounds

Indicates ratings that are limited by strength of material or factors other than stability (tipping)

LOAD CHART

HC 275

92HI Luffing Tip Boom + 77H Taper Tip Luffing Jib

195,000 lb + 64,000 lb CB 360° ANSI B 30.5

Boom Angle = 88 degrees

Boom length (feet)		110						
Radius (feet)	Luffer length (feet)							
	100	120	140	160	180	200	220	240
50	100.880	91.960	81.150	-	-	-	-	-
60	88.380	81.560	76.340	70.490	64.530	-	-	-
70	77.870	73.060	68.320	63.630	59.140	54.770	50.470	-
80	68.350	64.710	61.080	57.430	53.860	50.220	46.630	43.270
90	60.330	57.430	54.650	51.800	48.840	46.000	42.990	40.060
100	53.780	51.200	48.990	46.770	44.410	41.990	39.590	40.606
120	-	41.640	39.910	39.780	38.660	37.430	36.180	34.830
140	-	-	34.120	33.050	32.230	31.440	30.570	29.620
160	-	-	-	28.260	27.350	26.710	26.050	25.370
180	-	-	-	-	23.870	23.080	22.490	21.930
200	-	-	-	-	-	20.550	19.750	19.220
220	-	-	-	-	-	-	17.850	17.030
240	-	-	-	-	-	-	-	13.580

Boom length (feet)		130						
Radius (feet)	Luffer length (feet)							
	100	120	140	160	180	200	220	240
50	89.400	80.220	-	-	-	-	-	-
60	80.120	74.350	68.690	62.690	-	-	-	-
70	71.160	66.440	61.930	57.730	53.500	49.510	44.860	-
80	63.410	59.520	55.860	52.330	48.970	45.640	42.350	39.380
90	56.820	53.490	50.460	47.540	44.640	41.930	39.300	39.380
100	51.400	48.290	45.700	43.260	40.810	39.410	38.740	37.050
120	-	40.240	38.790	37.270	35.850	34.460	33.010	31.570
140	-	-	33.110	31.560	30.360	29.270	28.160	27.040
160	-	-	-	27.480	26.150	25.170	24.250	23.340
180	-	-	-	-	23.240	22.040	21.150	20.340
200	-	-	-	-	-	19.900	18.770	17.960
220	-	-	-	-	-	-	17.200	16.190
240	-	-	-	-	-	-	-	14.240

All ratings in pounds

Indicates ratings that are limited by strength of material or factors other than stability (tipping)

LOAD CHART

HC 275

92HI Luffing Tip Boom + 77H Taper Tip Luffing Jib

195,000 lb + 64,000 lb CB 360° ANSI B 30.5

Boom Angle = 88 degrees

Boom length (feet)		150						
Radius (feet)	Luffer length (feet)							
	100	120	140	160	180	200	220	240
50	72.390	65.080	-	-	-	-	-	-
60	67.670	62.320	56.070	50.740	-	-	-	-
70	60.790	56.540	52.430	48.700	44.140	40.230	-	-
80	55.050	51.100	47.730	44.490	41.340	39.290	38.550	35.780
90	50.050	46.580	43.400	40.680	39.710	37.550	35.420	33.400
100	45.920	42.460	39.790	38.540	36.440	34.500	32.610	30.790
120	-	36.920	34.460	32.600	30.900	29.330	27.780	26.280
140	-	-	30.100	28.110	26.560	25.200	23.880	22.610
160	-	-	-	25.010	23.250	21.950	20.750	19.620
180	-	-	-	-	21.020	19.480	18.280	17.210
200	-	-	-	-	-	17.870	16.460	15.320
220	-	-	-	-	-	-	15.280	13.950
240	-	-	-	-	-	-	-	12.430

Boom length (feet)		170						
Radius (feet)	Luffer length (feet)							
	100	120	140	160	180	200	220	240
50	62.870	56.810	-	-	-	-	-	-
60	60.310	54.020	48.820	44.410	-	-	-	-
70	54.470	50.420	46.640	42.150	39.270	38.010	-	-
80	49.470	45.890	42.630	39.610	38.510	36.050	33.290	30.880
90	45.250	41.920	39.850	37.570	35.300	33.240	31.300	29.250
100	41.750	39.160	36.620	34.460	32.410	30.540	28.720	26.990
120	-	33.800	31.290	29.350	27.590	25.980	24.430	22.940
140	-	-	27.570	25.560	23.830	22.380	20.990	19.660
160	-	-	-	22.850	21.030	19.560	18.250	17.020
180	-	-	-	-	19.090	17.480	16.110	14.920
200	-	-	-	-	-	16.080	14.510	13.280
220	-	-	-	-	-	-	13.560	12.080
240	-	-	-	-	-	-	-	11.020

Boom length (feet)		190		
Radius (feet)	Luffer length (feet)			
	100	120	140	160
50	53.250	48.290	-	-
60	50.660	45.390	41.240	39.760
70	47.190	43.420	39.380	37.370
80	43.050	39.760	37.830	35.410
90	40.110	37.210	34.600	32.360
100	37.140	34.300	31.810	29.710
120	-	29.770	27.390	25.390
140	-	-	24.200	22.180
160	-	-	-	19.900

All ratings in pounds

Indicates ratings that are limited by strength of material or factors other than stability (tipping)

RANGE DIAGRAM

HC 275

77H Taper Tip Luffing Jib + 16HL Fixed Jib

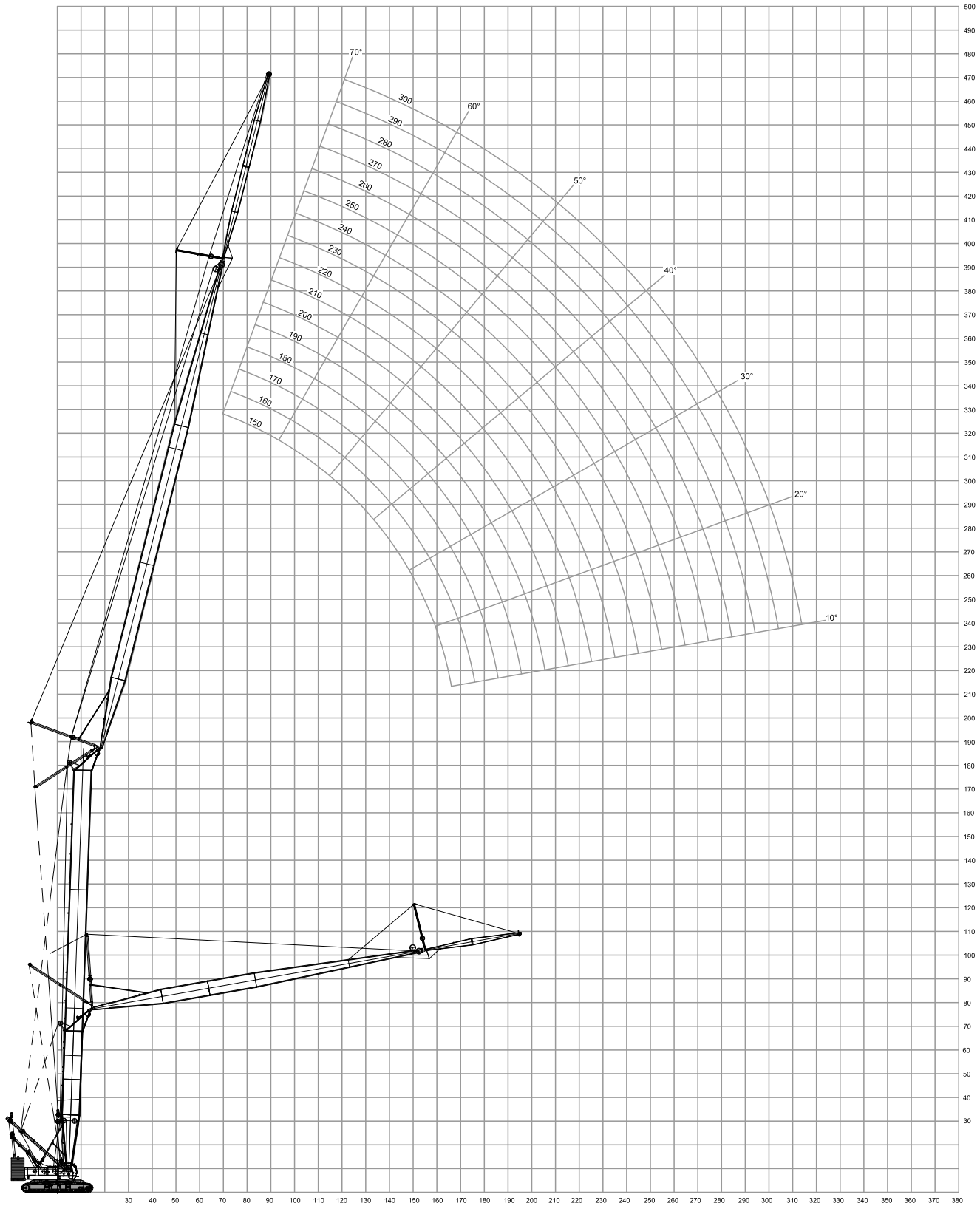

LOAD CHART

HC 275

With 92HI Luffing Tip Boom + 77H Taper Tip Luffing Jib + 16HL Fixed Jib

195,000 lb + 64,000 lb CB 360° ANSI B 30.5

Boom Angle = 88 degrees – Jib 5 degree Offset

Boom length (feet)		70								
Luffer length (feet)		100			120			140		
Radius (feet)	Fixed jib length (feet)	40	60	80	40	60	80	40	60	80
60		32.000	-	-	32.000	-	-	-	-	-
70		32.000	-	-	32.000	-	-	32.000	-	-
80		32.000	-	-	32.000	-	-	32.000	-	-
90		29.810	-	-	32.000	-	-	32.000	-	-
100		26.630	-	-	29.780	-	-	32.000	-	-
120		22.000	-	-	24.630	-	-	27.200	-	-
140		18.840	-	-	21.060	-	-	23.260	-	-
160		-	-	-	18.500	-	-	20.380	-	-
180		-	-	-	-	-	-	18.240	-	-

Boom length (feet)		70								
Luffer length (feet)		160			180			200		
Radius (feet)	Fixed jib length (feet)	40	60	80	40	60	80	40	60	80
70		32.000	-	-	-	-	-	-	-	-
80		32.000	-	-	32.000	-	-	32.000	-	-
90		32.000	-	-	32.000	-	-	32.000	-	-
100		32.000	9.070	-	32.000	9.230	-	32.000	-	18.320
120		29.710	6.370	-	32.000	6.450	-	32.000	6.520	18.060
140		25.430	4.840	-	28.040	4.890	-	29.640	4.920	17.320
160		22.270	3.880	-	24.500	3.890	-	25.980	3.910	15.030
180		19.870	3.220	-	21.800	3.220	-	23.160	3.220	13.260
200		18.040	2.750	-	19.680	2.740	-	20.920	2.730	11.850
220		-	-	-	17.880	2.390	-	18.130	2.360	10.740
240		-	-	-	-	-	-	15.740	2.100	9.830
260		-	-	-	-	-	-	-	-	9.100
280		-	-	-	-	-	-	-	-	8.560

Boom length (feet)		70								
Luffer length (feet)		220			240					
Radius (feet)	Fixed jib length (feet)	40	60	80	40	60	80			
90		32.000	-	-	32.000	-	-			
100		32.000	-	17.760	32.000	-	17.240			
120		32.000	6.610	17.490	32.000	6.730	16.940			
140		31.660	4.970	17.280	32.000	5.030	16.690			
160		27.780	3.930	15.950	29.560	3.950	16.510			
180		24.770	3.220	14.090	25.690	3.230	14.910			
200		21.450	2.730	12.600	21.670	2.720	13.340			
220		18.340	2.350	11.410	17.970	2.340	12.080			
240		15.900	2.070	10.430	14.970	2.040	11.040			
260		12.020	-	9.640	12.530	1.820	10.180			
280		-	-	8.990	8.680	-	9.470			
300		-	-	8.510	-	-	8.900			
320		-	-	-	-	-	6.340			

All ratings in pounds

 Indicates ratings that are limited by strength of material or factors other than stability (tipping)

LOAD CHART

HC 275

With 92HI Luffing Tip Boom + 77H Taper Tip Luffing Jib + 16HL Fixed Jib

195,000 lb + 64,000 lb CB 360° ANSI B 30.5

Boom Angle = 88 degrees – Jib 5 degree Offset

Boom length (feet)		100								
Luffer length (feet)		100			120			140		
Radius (feet)	Fixed jib length (feet)	40	60	80	40	60	80	40	60	80
60		32.000	-	-	32.000	-	-	-	-	-
70		32.000	-	-	32.000	-	-	32.000	-	-
80		32.000	-	-	32.000	-	-	32.000	-	-
90		30.120	-	-	32.000	-	-	32.000	-	-
100		26.860	-	-	30.040	-	-	32.000	-	-
120		22.120	-	-	24.790	-	-	27.380	-	-
140		18.900	-	-	21.150	-	-	23.370	-	-
160		-	-	-	18.540	-	-	20.440	-	-
180		-	-	-	-	-	-	18.260	-	-

Boom length (feet)		100								
Luffer length (feet)		160			180			200		
Radius (feet)	Fixed jib length (feet)	40	60	80	40	60	80	40	60	80
70		32.000	-	-	-	-	-	-	-	-
80		32.000	-	-	32.000	-	-	32.000	-	-
90		32.000	-	-	32.000	-	-	32.000	-	-
100		32.000	11.200	-	32.000	11.200	-	32.000	-	16.650
120		29.910	10.230	-	32.000	10.420	-	32.000	10.590	16.290
140		25.560	7.830	-	27.690	7.940	-	29.780	8.040	16.030
160		22.350	6.290	-	24.220	6.350	-	26.080	6.420	15.060
180		19.900	5.210	-	21.570	5.270	-	23.210	5.300	13.260
200		18.050	4.450	-	19.490	4.490	-	20.750	4.520	11.850
220		-	-	-	17.880	3.900	-	18.210	3.920	10.710
240		-	-	-	-	-	-	16.340	3.460	9.800
260		-	-	-	-	-	-	-	-	9.070
300		-	-	-	-	-	-	-	-	8.510

Boom length (feet)		100								
Luffer length (feet)		220			240					
Radius (feet)	Fixed jib length (feet)	40	60	80	40	60	80			
90		32.000	-	-	32.000	-	-			
100		32.000	-	16.080	32.000	-	-			
120		32.000	10.810	15.670	32.000	11.040	15.110			
140		31.820	8.160	15.400	32.000	8.290	14.770			
160		27.800	6.500	15.200	27.460	6.570	14.540			
180		23.730	5.360	14.110	23.430	5.410	14.370			
200		20.440	4.540	12.600	20.190	4.580	13.350			
220		17.850	3.930	11.390	17.570	3.950	12.070			
240		15.850	3.460	10.410	15.150	3.460	11.020			
260		13.360	-	9.600	12.670	3.090	10.150			
280		-	-	8.950	9.890	-	9.440			
300		-	-	8.460	-	-	8.850			
320		-	-	-	-	-	7.370			

All ratings in pounds

 Indicates ratings that are limited by strength of material or factors other than stability (tipping)



LOAD CHART

HC 275

With 92HI Luffing Tip Boom + 77H Taper Tip Luffing Jib + 16HL Fixed Jib

195,000 lb + 64,000 lb CB 360° ANSI B 30.5

Boom Angle = 88 degrees – Jib 5 degree Offset

Boom length (feet)		150								
Luffer length (feet)		100			120			140		
Radius (feet)	Fixed jib length (feet)	40	60	80	40	60	80	40	60	80
60		32.000	-	-	-	-	-	-	-	-
70		32.000	-	-	32.000	-	-	32.000	-	-
80		32.000	-	-	32.000	-	-	32.000	-	-
90		30.660	-	-	32.000	-	-	32.000	-	-
100		27.260	-	-	30.490	-	-	32.000	-	-
120		22.350	-	-	25.050	-	-	27.680	-	-
140		19.020	-	-	21.300	-	-	23.560	-	-
160		-	-	-	18.620	-	-	20.550	-	-
180		-	-	-	-	-	-	18.310	-	-

Boom length (feet)		150								
Luffer length (feet)		160			180			200		
Radius (feet)	Fixed jib length (feet)	40	60	80	40	60	80	40	60	80
80		31.630	-	-	29.790	-	-	28.230	-	-
90		30.640	-	-	28.780	-	-	27.090	-	-
100		29.800	11.200	-	27.860	-	-	26.110	-	13.500
120		28.590	11.200	-	26.410	11.200	-	24.600	11.200	12.920
140		25.770	11.200	-	24.950	11.200	-	23.460	11.200	12.440
160		22.480	10.370	-	18.870	10.520	-	20.460	10.660	12.090
180		19.980	8.600	-	16.810	8.720	-	17.820	8.830	11.910
200		18.070	7.340	-	15.410	7.440	-	15.740	7.540	11.840
220		-	-	-	-	6.460	-	14.170	6.530	10.680
240		-	-	-	-	-	-	13.130	5.740	9.760
260		-	-	-	-	-	-	-	-	9.000
280		-	-	-	-	-	-	-	-	8.430

Boom length (feet)		150								
Luffer length (feet)		220			240					
Radius (feet)	Fixed jib length (feet)	40	60	80	40	60	80			
80		28.230	-	-	-	-	-			
90		27.090	-	-	25.600	-	-			
100		26.110	-	12.930	24.580	-	-			
120		24.600	11.200	12.260	22.900	11.200	11.680			
140		23.460	11.200	11.730	21.650	11.200	11.090			
160		20.460	10.860	11.340	19.390	10.610	10.600			
180		17.820	8.970	11.030	16.810	9.110	10.220			
200		15.740	7.630	10.850	14.750	7.710	9.970			
220		14.170	6.610	10.840	13.140	6.500	9.820			
240		13.130	5.800	10.360	11.940	5.500	9.810			
260		-	5.180	9.550	11.150	4.870	9.560			
280		-	-	8.890	-	-	8.730			
300		-	-	8.380	-	-	7.610			
320		-	-	-	-	-	6.090			

All ratings in pounds

Indicates ratings that are limited by strength of material or factors other than stability (tipping)

LOAD CHART

HC 275

With 92HI Luffing Tip Boom + 77H Taper Tip Luffing Jib + 16HL Fixed Jib

☰ 195,000 lb + 64,000 lb CB 360° ANSI B 30.5

Boom Angle = 88 degrees – Jib 5 degree Offset

Boom length (feet)		200					
Luffer length (feet)		100			120		
Radius (feet)	Fixed jib length (feet)	40	60	80	40	60	80
60		30.190	-	-	-	-	-
70		28.730	-	-	26.640	-	-
80		27.670	-	-	25.390	-	-
90		26.820	-	-	24.370	-	-
100		26.270	-	-	23.630	-	-
120		22.590	-	-	22.770	-	-
140		19.150	-	-	20.610	-	-
160		-	-	-	18.250	-	-

All ratings in pounds

Indicates ratings that are limited by strength of material or factors other than stability (tipping)

NOTES TO LIFTING CAPACITY

HC 275

Luffing Jib Chart Information

Maximum Boom & Luffing Jib Self-Erection Data 92HI Luffing Tip Boom + 77H Taper Tip Luffing Jib Over the end (blocked)	
Boom length (feet)	Luffing jib length (feet)
180	240
190	170
200	120
210	0

Maximum Boom & Luffing Jib Self-Erection Data 92HI Luffing Jib Tip Boom + 77H Taper Tip Luffing Jib + 16HL Fixed Jib Over the end (blocked)		
Boom length (feet)	Luffing jib length (feet)	Fixed jib length (feet)
200	120	40
190	170	60
180	240	60
180	230	70
180	220	80
170	240	70
170	230	80
160	240	80

Load Hoisting Information – 1 1/8 Inch Diameter EEIPS Wire Rope			
Maximum Lifting Capacity (lb)	Minimum Parts of line	Maximum hoisting distance (feet)	
		Main hoist	Auxiliary hoist
163.420	4	325	325
122.570	3	435	435
81.710	2	655	655
40.850	1	1.310	1.310

Boom Composition Chart – 92HI Luffing Tip Boom

Boom length (feet)	25' 92HI Inner ¹⁾	20' 92HT Center	10' 92ST Center	50' 92ST Center	15' 92HI Center	10' Luffing Boom Tip
70	1	1	0	0	1	1
80	1	1	1	0	1	1
90	1	1	2	0	1	1
100	1	0	0	1	1	1
110	1	0	1	1	1	1
120	1	1	0	1	1	1
130	1	1	1	1	1	1
140	1	1	2	1	1	1
150	1	0	0	2	1	1
160	1	0	1	2	1	1
170	1	1	0	2	1	1
180	1	1	1	2	1	1
190	1	1	2	2	1	1
200	1	0	0	3	1	1

¹⁾ Special 25' 92HI inner with modifications made for luffing jib application

Luffing Jib Composition Chart – 77H Taper Tip Luffing Jib

Jib length (feet)	30' 77S Inner ¹⁾	10' 77S Center	20' 77S Center	50' 77S Center	40' 77H Center	30' 77HT Tapper Tip ²⁾
100	1	0	0	0	1	1
110	1	1	0	0	1	1
120	1	0	1	0	1	1
130	1	1	1	0	1	1
140	1	0	2	0	1	1
150	1	0	0	1	1	1
160	1	1	0	1	1	1
170	1	0	1	1	1	1
180	1	1	1	1	1	1
190	1	0	2	1	1	1
200	1	0	0	2	1	1
210	1	1	0	2	1	1
220	1	0	1	2	1	1
230	1	1	1	2	1	1
240	1	0	2	2	1	1

¹⁾ Special 30' 77S inner for HC 275 luffing jib application

²⁾ Special 30' 77HT taper tip outer for HC 275 luffing jib application

Hydraulic Crawler Crane

Maximum lifting capacity

275 tons.

300 ft maximum lift crane boom

- 92Hl tubular chord boom, pin connected.
- 65 ft inner and outer and 10 / 15 / 20 / 50 ft available inserts provide boom compositions in 10 ft increments from 65 ft to 300 ft.

Robust engine

- Cummins Model QSL9-C diesel engine supplies 325 HP (242 kW) @ 2000 rpm, 542 cu. in. displacement, 180 gallons fuel capacity.

Environmental operator's cab

- Designed to provide excellent viewing range and quiet, comfortable operation.
- 37 in. wide cab has wide curved windows on both top and bottom.
- Easy-to-operate modular and ergonomically designed controls reduce operator fatigue and increase productivity.
- Load moment indicator with interactive screen features a shockless stop system. Operator can select from three display modes: loaded condition diagram, rated lifting curve, and rated lifting load table.
- Adjustable operator's seat, radio, air conditioner, overhead window, sun visor, fan, overhead and front wipers, and drum rotation indicators standard.

Heavy duty carbody and crawlers

- Fabricated steel carbody is deep box constructed with square axles for the crawler side frames. Precision machined top supports anti-friction swing circle and multiple pass hydraulic swivel joint.
- Crawlers have high alloy steel tumbler yokes and rigid fabricated structures with built-in sealed automatic lubrication system.
- 48" crawler shoes.
- Travel mechanism is set within shoe width.
- Side frames extended or retracted by cylinders inside the carbody.
- Two travel speed settings - 0.55 / 0.37 mph.
- 30 % (17°) gradeability.

Powerful, high-speed hoist system

- Two identical independent main and auxiliary load hoisting drums provide ample lifting power. Drums are grooved for 1-1/8 in. diameter rope. Max. line speed is 540 fpm, max. single line pull is 54,060 lb. Rated single line pull is 40,850 lb. Freefall on main and auxiliary drums.
- Each drum, including optional third, has power up/down. Load hoists are further controllable in stepless mode.
- Ample work space in front of drums allows easy access for cable installation and maintenance.
- External contracting brake.
- Internal expanding band clutch.
- Separate caption for swing.
- 1.7 rpm swing speed.

High capacity, dependable hydraulic system

- Open circuit system has 2 variable displacement piston pumps which supply power to the travel and hoisting functions, 3 gear pumps provide power for swing, hydraulic cylinders and pilot pressure.
- Hydraulic reservoir with 90 gallons capacity and 10 micron filtration. System capacity is 150 gallons.
- Component working range is between -4 and 203° F.

Fourteen piece removable counterweight

- 13 piece pin connected counterweight can be assembled or disassembled easily within minutes.
- Hydraulic counterweight removal system is standard and makes the HC 275 one of the most transportable cranes in its class.
- Moves on 11 trucks with 260 ft boom and 105 ft of jib. At 11 ft 6 in. wide and 11 ft 3 in. high, the basic HC 275 will transport on a standard lowboy trailer.

Options include

- Third drum.
- Single sheave extension.
- Choice of 16HL - 32,000 lb or #30 - 60,000 lb capacity jib.
- Reeving winch.
- Luffing jib.

TRANSPORT EXAMPLE FOR HC 275

HC 275

260' 92HI Boom with six sheave offset tip & 105' of jib

Loads required as follows: (weights shown do **NOT** include blocking or tie-down material)

LOAD NO. 1	
3 x counterweight overlays @ 11,150 lb each	33,450 lb
1 x 50' boom center section	5,000 lb
TOTAL LOAD	38,450 lb
LOAD NO. 2	
3 x counterweight overlays @ 11,150 lb each	33,450 lb
1 x 50' boom center section	5,000 lb
TOTAL LOAD	38,450 lb
LOAD NO. 3	
3 x counterweight overlays @ 11,150 lb each	33,450 lb
1 x 50' boom center section	5,000 lb
TOTAL LOAD	38,450 lb
LOAD NO. 4	
2 x counterweight overlays @ 11,150 lb each	22,300 lb
40' six sheave outer section	6,660 lb
TOTAL LOAD	28,960 lb
LOAD NO. 5	
25' boom inner section	6,500 lb
Front carbody counterweight	32,000 lb
TOTAL LOAD	38,500 lb
LOAD NO. 6	
3 x counterweight overlays @ 11,150 lb each	33,450 lb
1 x 20' boom center section	3,550 lb
1 x 10' boom center section	1,795 lb
1 x 15' boom center section	2,750 lb
TOTAL LOAD	41,545 lb
LOAD NO. 7	
Base counterweight	39,000 lb
TOTAL LOAD	39,000 lb
LOAD NO. 8	
Crawler side frame	48,000 lb
TOTAL LOAD	48,000 lb
LOAD NO. 9	
Crawler side frame	48,000 lb
TOTAL LOAD	48,000 lb
LOAD NO. 10	
Rear carbody counterweight	32,000 lb
12.5' jib inner	965 lb
12.5' jib outer	910 lb
Jib mast	900 lb
2 x 10' jib center sections @ 460 each	920 lb
2 x 30' jib center sections @ 1,300 each	2,600 lb
Miscellaneous	5,000 lb
TOTAL LOAD	43,295 lb
LOAD NO. 11	
Upperworks and Carbody	105,000 lb

www.terexcranes.com

Effective Date: November 2010.

Product specifications and prices are subject to change without notice or obligation. The photographs and/or drawings in this document are for illustrative purposes only. Refer to the appropriate Operator's Manual for instructions on the proper use of this equipment. Failure to follow the appropriate Operator's Manual when using our equipment or to otherwise act irresponsibly may result in serious injury or death. The only warranty applicable to our equipment is the standard written warranty applicable to the particular product and sale and Terex makes no other warranty, express or implied. Products and services listed may be trademarks, service marks or trade-names of Terex Corporation and/or its subsidiaries in the USA and other countries. All rights are reserved. Terex® is a registered trademark of Terex Corporation in the USA and many other countries.

Copyright 2010 Terex Corporation

Terex Cranes, Global Marketing, Dinglerstraße 24, 66482 Zweibrücken, Germany
Tel. +49 (0) 6332 830, Email: info.cranes@terex.com, www.terexcranes.com

Brochure Reference: TC-DS-I-E-HC275-11/10



WORKS FOR YOU.™